

# AOSOME®

*Power Products*

---

## INSTRUCTION MANUAL MULTI-FUNCTIONAL TOOL 5IN1 ASMT 2600-3

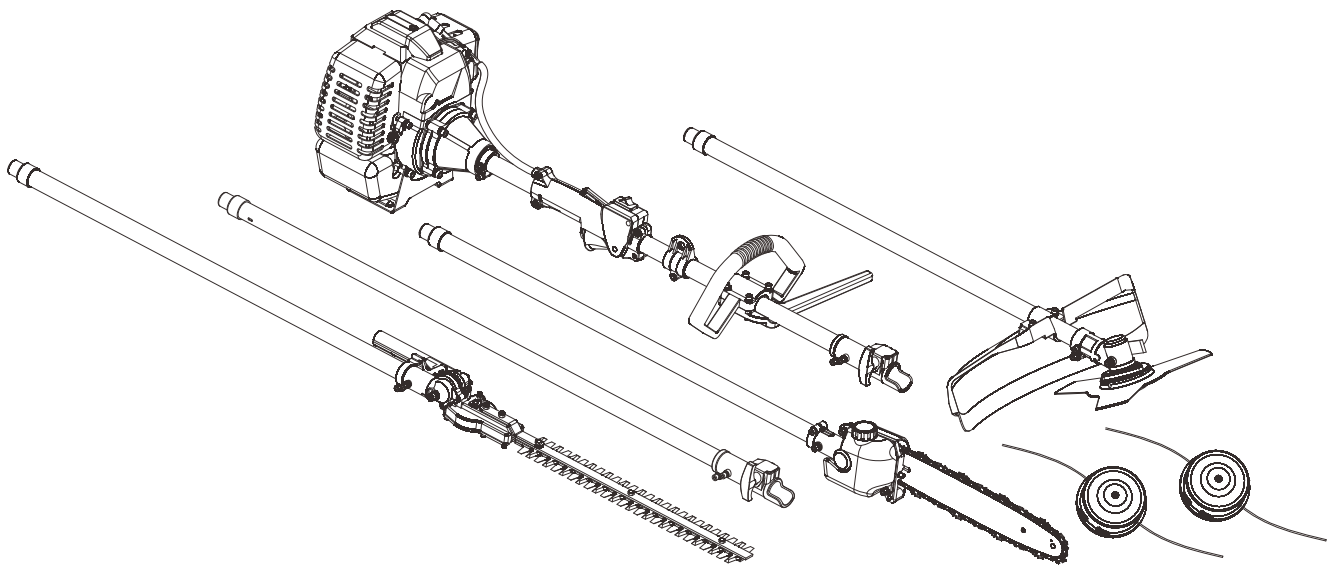

### DEAR CUSTOMER



In order to achieve the best performance of your product, please read this instruction manual carefully before using, and keep it for future reference.

# CONTENTS

1.Parts location.....	01
2.Warning labels on the machine .....	02
3.Symbols on the machine .....	02
4.For safety operation.....	04
5.Set up .....	08
6.Fuel and chain oil.....	11
7.Operation .....	12
8.Maintenance.....	20
9.Disposal.....	26
10.Trouble shooting guide.....	26

## 1. Parts location

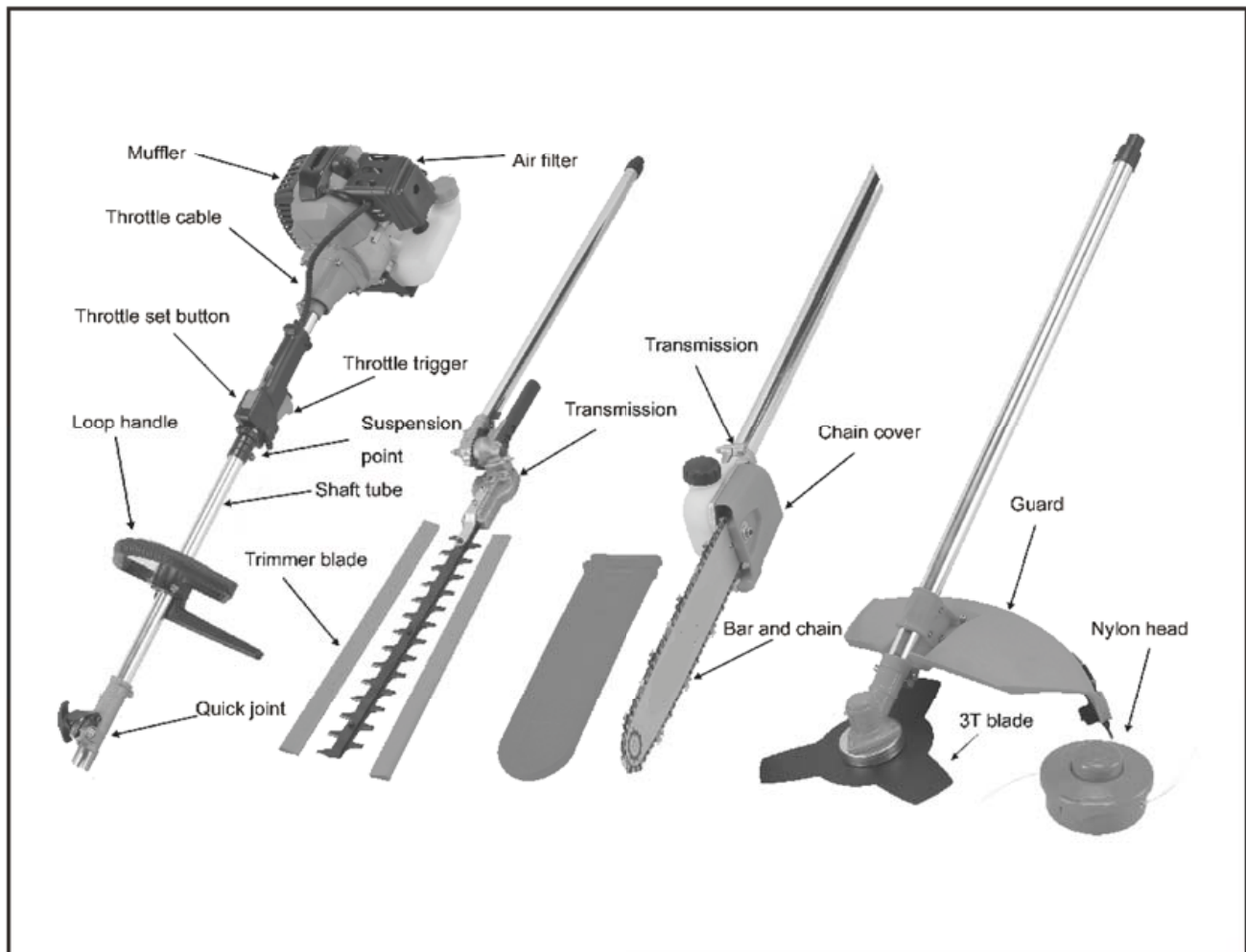

## 2. Warning labels on the machine



- (1) Read owners manual before operating this machine.
- (2) Wear head, eye and ear protection.
- (3) Wear foot protection.
- (4) Wear gloves.
- (5) Beware of thrown objects.
- (6) Warning / Attention
- (7) Keep all children, bystanders and helpers 15 meters away from the machine.

 If warning label peels off or becomes soiled and impossible to read, you should contact the dealer from which you purchased the product to order new labels and affix them in the required location(s).

 **Never modify your machine.**  
**We won warrant the machine, if you use the remodeled brushcutter or if you don observe the proper usage written in the manual.**

## 3. Symbols on the machine

For safe operation and maintenance, symbols are carved in relief on the machine. According to these indications, please be careful not to make a mistake.



The port to refuel the IX GASOLINE  
**Position:** FUEL TANK CAP



The direction to close the choke  
**Position:** AIR CLEANER COVER



The direction to open the choke  
**Position:** AIR CLEANER COVER



If you turn the rod by screwdriver follow the arrow to the AX position, the chain oil flow more, and if you turn to the IN position, less.  
**Position:** Bottom of the TRANSMISSION

## ▲ 4. For safe operation



1. Read this manual carefully until you completely understand and follow all safety and operating instructions.
2. Keep this manual handy so that you may refer to it later whenever any questions arise. Also note, if you have any questions which cannot be answered herein, contact the dealer from whom you purchased the product.
3. Always be sure to include this manual when selling, lending, or otherwise transferring the ownership of this product.
4. Never allow children or anyone unable to fully understand the directions given in the manual to use the machine.



### WORKING CONDITION

1. When using the product, you should wear proper clothing and protective equipment.



- (1) Helmet
- (2) Ear protectors
- (3) Protection goggles or face protector
- (4) Thick work gloves
- (5) Non-slip-sole work boots

2. And you should carry with you.
  - (1) Attached tools
  - (2) Properly reserved fuel
  - (3) Spare blade
  - (4) Things to notify your working area (rope, warning signs)
  - (5) Whistle (for collaboration or emergency)
  - (6) Hatchet or saw (for removal of obstacles)



3. Do not wear loose clothing, jewelry, short trousers, sandals, or go barefoot. Do not wear anything which might be caught by a moving part of the unit. Secure hair so it is above shoulder length.

### WORKING CIRCUMSTANCE

1. Never start the engine inside a closed room or building. Exhaust gases contain dangerous carbon monoxide.
2. Never use the product,
  - a. when the ground is slippery or when you can't maintain a steady posture.



- b. At night, at times of heavy fog, or at any other times when your field of vision might be limited and it would be difficult to gain a clear view of the working area.
- c. During rain storms, during lightning storms, at times of strong or gale-force winds, or at any other times when weather conditions might make it unsafe to use the product.

### WORKING PLAN

1. You should never use the product when under the influence of alcohol, when suffering from exhaustion or lack of sleep, when suffering from drowsiness as a result of having taken cold medicine or at any other time when a possibility exists that your judgment might be impaired or that you might not be able to operate the product properly and in a safe manner.
2. When planning your work schedule, allow plenty of time to rest. Limit the amount of time over which the product is to be used continuously to somewhere around 30 ~ 40 minutes per session, and take 10 ~ 20 minutes of rest between work sessions. Also try to keep the total amount of work performed in a single day under 2 hours or less.



### ▲ WARNING

1. If you don't observe the working time, or working manner (See **SING THE PRODUCT** ), Repetitive Stress Injury (RSI) could occur.  
If you feel discomfort, redness and swelling of your fingers or any other part of your body, see a doctor before getting worse.
2. To avoid noise complaints, in general, operate product between 8 a.m. and 5 p.m. on weekdays and 9 a.m. to 5 p.m. on weekends.



### NOTE

Check and follow the local regulations as to sound level and hours of operations for the product.

## ▲ 4. For safe operation

### BEFORE STARTING THE ENGINE



1. The area within a perimeter of 15 m of the person using the product should be considered a hazardous area into which no one should enter. If necessary, yellow warning rope, warning signs should be placed around the perimeter of the area. When work is to be performed simultaneously by two or more persons, care should also be taken to constantly look around or otherwise check for the presence and locations of other people working so as to maintain a distance between each person sufficient to ensure safety.
2. Check the condition of working area to avoid any accident by hitting hidden obstacles such as stumps, stones, cans, or broken glass.



### ❗ IMPORTANT

Remove any obstacle before beginning work.



3. Inspect the entire unit for loose fasteners and fuel leakage. Make sure that the cutting attachment is properly installed and securely fastened.
4. Be sure the cutting attachment guard is firmly attached in place.
5. Always use the harness. Adjust the strap for comfort before starting the engine. The strap should be adjusted so the left hand can comfortably hold the handlebar grip approximately waist high.

### STARTING THE ENGINE



1. Keep bystanders and animals at least 15 m away from the operating point. If you are approached, immediately stop the engine.
2. The product is equipped with a centrifugal clutch mechanism, so the cutting attachment begins to rotate as soon as the engine is started by putting the throttle into the start position. When starting the engine, place the product onto the ground in a flat clear area and hold it firmly in place so as to ensure that neither the cutting part nor the throttle come into

contact with any obstacle when the engine starts.

### ▲ WARNING

**Never place the throttle into the high-speed position when starting the engine.**

3. After starting the engine, check to make sure that the cutting attachment stops rotating when the throttle is moved fully back to its original position. If it continues to rotate even after the throttle has been moved fully back, turn off the engine and take the unit to your authorized servicing dealer for repair

### USING THE PRODUCT

### ❗ IMPORTANT



Cut only materials recommended by the manufacturer. And use only for tasks explained in the manual.



1. Grip the handles firmly with both hands using your whole hand. Place your feet slightly apart (slightly further apart than the width of your shoulders) so that your weight is distributed evenly across both legs, and always be sure to maintain a steady, even posture while working.
2. Keep cutting attachment below waist level.
3. Maintain the speed of the engine at the level required to perform cutting work, and never raise the speed of the engine above the level necessary.
4. If the unit starts to shake or vibrate, turn off the engine and check the whole unit. Do not use it until the trouble has been properly corrected.
5. Keep all parts of your body away from rotating cutting attachment and hot surfaces.
6. Never touch the muffler, spark plug, or other metallic parts of the engine while the engine is in operation or immediately after shutting down the engine. Doing so could result in serious burns or electrical shock.



## ▲ 4. For safe operation



7. Never operate the pruner at an angle greater than 60 in order to reduce the risk of being struck by falling objects during operation.

### ▲ WARNING

**Approaching or contacting electric power lines with pruning saw may cause serious injury or death from electrocution.**

**Electricity can jump from one point to another by means of arcing or may be conducted through damp branches. Maintain a clearance of at least 15m between Pole saw and any electrical line carrying live current.**

### IF SOMEONE COMES

1. Guard against hazardous situations at all times. Warn adults to keep pets and children away from the area. Be careful if you are approached. Injury may result from flying debris.
2. If someone calls out or otherwise interrupts you while working, always be sure to turn off the engine before turning around.

### MAINTENANCE

1. In order to maintain your product in proper working order, perform the maintenance and checking operations described in the manual at regular intervals.
2. Always be sure to turn off the engine and disconnect the spark plug wire before performing any maintenance or checking procedures.

### ▲ WARNING

**The metallic parts reach high temperatures immediately after stopping the engine.**

3. When replacing the cutting attachment or any other part, or when replacing the oil or any lubricant, always be sure to use only authorized products or products which have been certified by your supplier
4. In the event that any part must be replaced or any maintenance or repair work not described in this

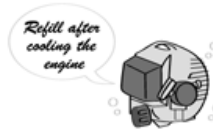
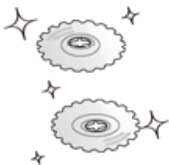

manual must be performed, please contact a representative from the store nearest ZENOAH authorized servicing dealer for assistance.

5. Do not use any accessory or attachment other than those bearing the ZENOAH mark and recommended for the unit.
6. Under no circumstances should you ever take apart the product or alter it in any way. Doing so might result in the product becoming damaged during operation or the product becoming unable to operate properly.

### HANDLING FUEL

1. The engine of our 4 in 1 product is designed to run on a mixed fuel, which contains highly flammable gasoline. Never store cans of fuel or refill the tank of the unit in any place where there is a boiler, stove, wood fire, electrical sparks, welding sparks, or any other source of heat or fire which might ignite the fuel.
2. Never smoke while operating the unit or refilling its fuel tank.
3. When refilling the tank, always turn off the engine and allow it to cool down. Take a careful look around to make sure that there are no sparks or open flames anywhere nearby before refueling.
4. Wipe spilled fuel completely using a dry rag if any fuel spillage occurs during refueling.
5. After refueling, screw the fuel cap back tightly onto the fuel tank and then carry the unit to a spot 3 m or more away from where it was refueled before turning on the engine.

### TRANSPORTATION

1. When hand-carrying the product, cover over the cutting part if necessary, lift up the product and carry it paying attention to the blade.
2. Never transport the product over rough roads over long distances by vehicle without removing all fuel from the fuel tank. If doing so, fuel might leak from the tank during transport.



## ▲ 4. For safe operation



1. When you finish cutting in one location and wish to continue work in another spot, turn off the engine, lift up the unit and carry it paying attention to the blade.
2. Never forget to place the protective cover over the blades.
3. When hand-carrying the product, cover over the cutting part if necessary, lift up the product and carry it paying attention to the blade.
4. Never transport the product over rough roads over long distances by vehicle without removing all fuel from the fuel tank. If doing so, fuel might leak from the tank during transport.



### KICKBACK SAFETY PRECAUTIONS FOR CHAIN SAW USERS

#### ▲ WARNING

Kickback may occur when the nose or tip of the guide bar touches an object, or when the wood closes in and pinches the saw chain in the cut. Tip contact in some cases may cause a lightning fast reverse reaction, kicking the guide bar up and back towards the operator. Pinching the saw chain along the top of the guide bar may push the guide bar rapidly back towards the operator. Either of these reactions may cause you to lose control of the saw, which could result in serious personal injury.

Do not rely exclusively on the safety devices built into your saw. As a chain saw user you should take several steps to keep cutting jobs free from accident or injury.

- (1) With a basic understanding of kickback you can reduce or eliminate the element of surprise. Sudden surprise contributes to accidents.
- (2) Keep a good grip on the saw with both hands, the right hand on the rear handle, and the left hand on the front handle, when the engine is running. Use a firm grip with thumbs and fingers encircling the chain saw handles. A firm grip will help you reduce kickback and maintain control of the saw.
- (3) Make certain that the area in which you are cutting is free from obstructions. Do not let the nose of the guide bar contact a log, branch, or any other obstruction which could be hit while you are operating the saw.
- (4) Cut at high engine speeds.



- (5) Follow the manufacturer's sharpening and maintenance instructions for the saw chain.
- (6) Only use replacement bars and chains specified by the manufacturer or the equivalent.

#### ▲ WARNING

Make sure the chain and sprocket are correctly adjusted before operating the pruner (see page 32–35 for adjustment procedures). Never attempt chain adjustment with the engine running!

Always make sure the cutting attachment is properly installed and firmly tightened before operation.

Never use a cracked or warped guide bar: replace it with a serviceable one and make sure it fits properly.

If a saw blade should bind fast in a cut, shut off the engine immediately. Push the branch or tree to ease the bind and free the blade.

Do not operate the pole pruner with the muffler removed.

When cutting a limb that is under tension, be alert for springback so that you will not be struck by the moving limb.

Always stop the engine immediately and check for damage if you strike a foreign object or if the machine becomes tangled. Do not operate with broken or damaged equipment.

#### ⓘ IMPORTANT

Do not make unauthorized modifications or substitutions to the guide bar or chain.

Never allow the engine to run at high RPM without a load. Doing so could damage the engine.

Keep the pruner as clean as possible. Keep it free of loose vegetation, mud, etc

# 5. Set up

## MOUNTING ENGINE

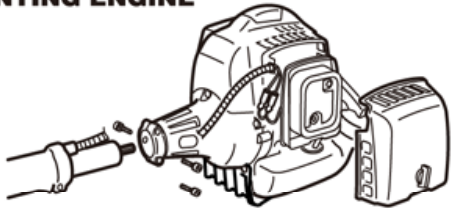

1. Push the shaft tube toward the clutch housing and rotate it by hand to check that the drive shaft is engaged with the gears.
2. Insert the shaft tube into the clutch housing until it bottoms, and align the positioning holes on the clutch housing and the shaft tube and install the screw. When difficult to engage, twist the engine slightly.
3. Fasten the clamp securely with two screws.

### IMPORTANT

Tighten the screws gradually by turns.

## CONNECTING THROTTLE WIRE

1. Remove the air cleaner cover.
2. Connect the end of the throttle wire to the joint on the top of the carburetor.

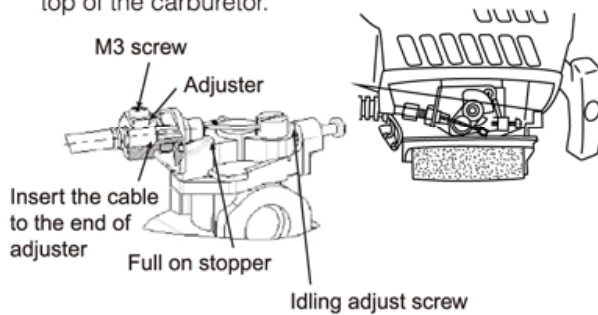

1. Connect throttle wire with carburetor. Insert the cable to the end of adjuster fix the throttle cable by tightening M3 screw. (Tightening torque: 0.4 ~ 0.8 N.m.)
2. Make sure the TOPPER-PLATE of carburetor moves to contact with IDLING ADJUST SCREW and the WING-ARM of carburetor moves to contact with FULL ON STOPPER by gripping throttle lever.

## CONNECTING SWITCH WIRES

Connect the switch wires between the engine and the main unit. Pair the wires of the same color.

## SUSPENSION POINT

### NOTE

Be the SUSPENSION POINT in the location of the arrow mark.

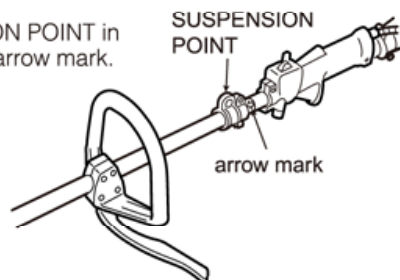

## INSTALLING HANDLE

### NOTE

The handle is put during the arrow mark.

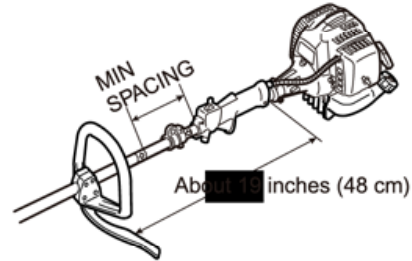

Mount the handle to the shaft tube and suspension point it at a location that is comfortable to you.

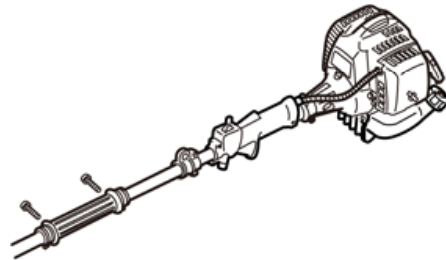

Insert the grip to the shaft tube. Fasten the clamps with screws.

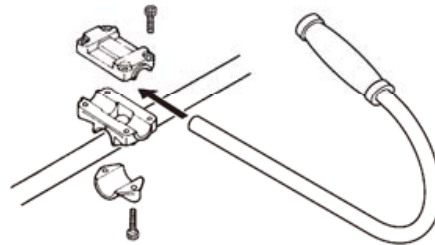

Install the J-shaped handle to the shaft tube and clamp at a position best for your job.

## JOINT ATTACHMENT

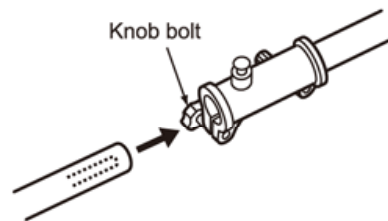

Insert the attachment to the main shaft. Tighten the knob bolt securely.



## 5. Set up

### INSTALLING CUTTING ATTACHMENT GUARD

Put the cutting attachment guard on the gearbox, attach it with the 4 screws and hardware provided.

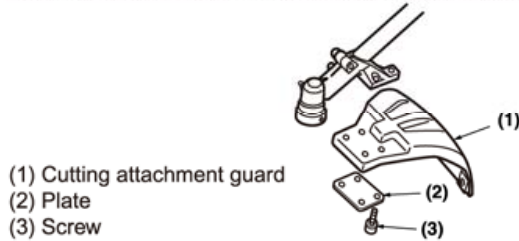

### INSTALLING CUTTING HEAD

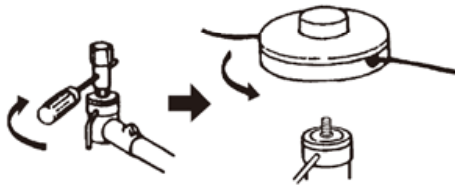

1. While locking the gear shaft, by inserting the supplied tool into the upper holder on the gearbox, loosen and remove the hexagon nut (left-handed).
2. Then screw in the cutting head to the gear shaft over the holders. Hand-tighten it securely.

### HARNESS

#### **▲ WARNING**

**ALWAYS WEAR THE PROVIDED HARNESS WHEN USING THE MACHINE!**

Always make sure the machine is hooked securely to the harness.

If you don't, you will be unable to control the machine safely. This can result in injury to yourself or others. Never use a harness with a defective quick release or any other damage.

### HOW TO WEAR

1. Wear the provided harness without twisted bands, with the hanger on your right side.

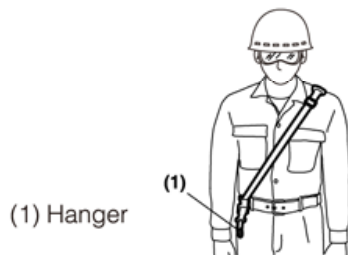

### BALANCE THE UNIT

1. Hook your machine to the hanger.
2. Adjust the bands of the harness to have the blade parallel to the ground when standing in your normal working position to provide you most effectiveness and comfort on operating the machine.
3. In order to prevent the hanger position to change during operation, turn up the extra part of the band from the buckle.

4. When correctly adjusted, check the correct working of the harnesses' QUICK RELEASE.



### QUICK RELEASE

The harness is equipped with a "QUICK RELEASE" device. To release the machine from the harness in emergency situations, please follow the procedure as explained below.

#### **▲ WARNING**

**Make sure to check proper working of the QUICK RELEASE device BEFORE operating the machine. Make sure to hold the unit securely when using the QUICK RELEASE.**

While holding the unit by your right hand securely, press both sides of the buckle. sides of the buckle.

- (1) Buckle



## 5. Set up

### ATTACHING THE TRIMMING MECHANISM

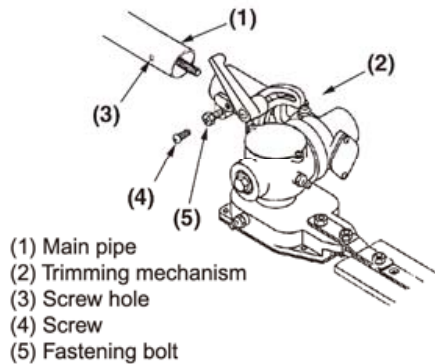

1. Remove the screw screwed into the end of the trimming mechanism.
2. Insert the end of the trimming mechanism into the main pipe.
3. Line up the hole on the end of the trimming mechanism into which the screw is to be inserted with the hole on the main pipe, and screw the screw firmly in.
4. Using a wrench, screw in the bolt provided to fix the trimming mechanism into place.

### BALANCE UNIT

1. Put on strap and attach unit to strap.
2. Depending on the working posture, slide clamp up or down until unit balances and the strap fits your body.

## 6. Set up

### ATTACHING THE PRUNING MECHANISM

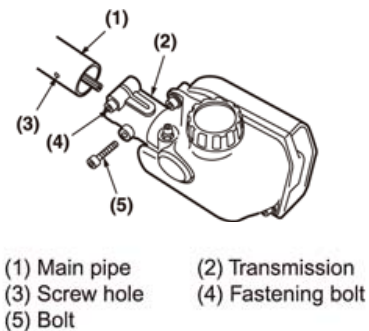

1. Remove the cap on the end of the main pipe.
2. Remove the screw screwed into the end of the transmission.
3. Insert the end of the gear case into the main pipe.
4. Line up the hole on the end of the transmission into which the screw is to be inserted with the hole on the main pipe, and screw the screw firmly in.
5. Using a wrench, screw in the bolt provided to fix the mechanism into place.

A standard package contains the items as shown below.

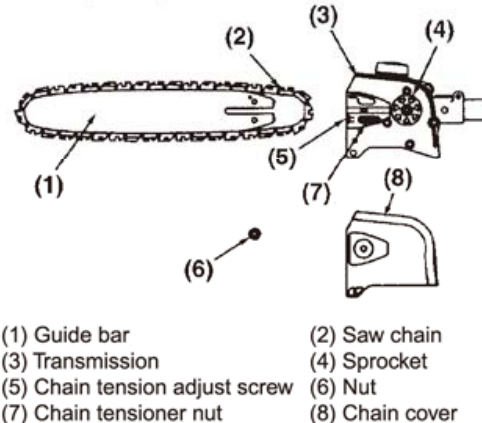

Install the guide bar and the saw chain on the transmission as follows.

#### ⚠ WARNING

The saw chain has very sharp edges. Use protective gloves for safety.

1. Loosen a nut and remove the chain cover.
2. Mount the guide bar then fit the saw chain around the bar and sprocket.

#### ⚠ WARNING

Pay attention to the correct direction of the saw chain.

3. Fit the chain tensioner nut into the lower hole of the guide bar, then install the chain cover, and fasten the mounting nut to finger tightness.

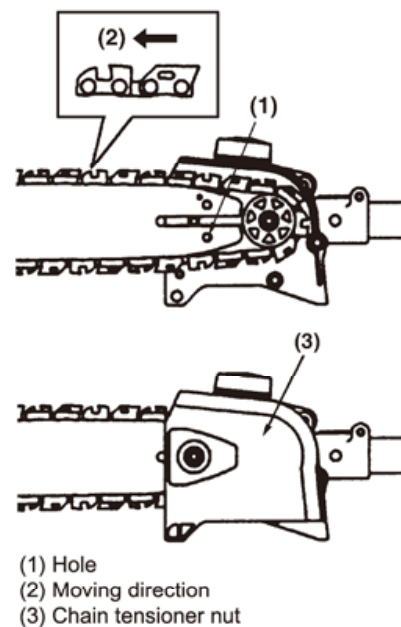

## 5. Set up

- Adjust the chain tension by turning the tensioner screw until the tie straps just touch the bottom side of the bar rail.

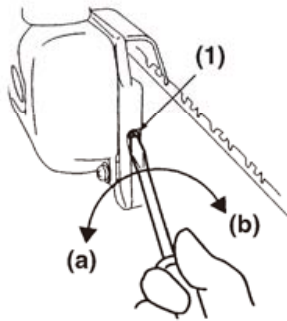

(1) Chain tension adjusting screw  
(a) Loosen (b) Tighten

- Tighten the mounting nut securely with the bar tip held up (TORQUE: 8.9 ~ 11.7 N.m./90 ~ 120 kg-cm). Then check the chain for smooth rotation and correct tension while moving it by hand. If necessary, readjust.

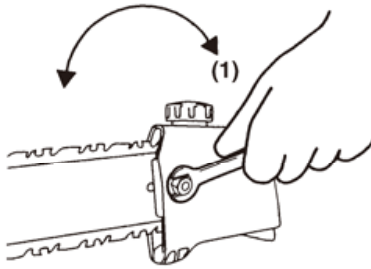

(1) Tighten

### **▲ WARNING**

It is very important to maintain the proper chain tension. Rapid wear of the guide bar or the chain coming off easily can be caused by improper tension. Especially when using a new chain, take good care of it since it should expand when first used.

### **BALANCE UNIT**

- Put on strap and attach unit to strap.
- Depending on the working posture, slide clamp up or down until unit balances and the strap fits your body.

## 6. Fuel and chain oil

### ■ FUEL

#### **▲ WARNING**

Gasoline is very flammable. Avoid smoking or bringing any flame or sparks near fuel. Make sure to stop the engine and allow it cool before refueling the unit. Select outdoor bare ground for fueling and move at least 3 m (10 ft) away from the fueling point before starting the engine.



### ■ RECOMMENDED MIXING RATIO GASOLINE 25 : OIL 1

(when using genuine oil)

Exhaust emission are controlled by the fundamental engine parameters and components (eq., carburation, ignition timing and port timing) without addition of any major hardware or the introduction of an inert material during combustion.

These engines are certified to operate on unleaded gasoline.

If you use a gasoline of a lower octane value than prescribed, there is a danger that the engine temperature may rise and an engine problem such as piston seizing may consequently occur.

Unleaded gasoline is recommended to reduce the contamination of the air for the sake of your health and the environment.

Poor quality gasolines or oils may damage sealing rings, fuel lines or fuel tank of the engine.

### ■ HOW TO MIX FUEL

#### **▲ WARNING**

Pay attention to agitation.

1. Measure out the quantities of gasoline and oil to be mixed.
2. Put some of the gasoline into a clean, approved fuel container.
3. Pour in all of the oil and agitate well.
4. Pour in the rest of gasoline and agitate again for at least one minute. As some oils may be difficult to agitate depending on oil ingredients, sufficient agitation is necessary for the engine to last long. Be

careful that, if the agitation is insufficient, there is an increased danger of early piston seizing due to abnormally lean mixture.

5. Put a clear indication on the outside of the container to avoid mixing up with gasoline or other containers.
6. Indicate the contents on outside of container for easy identification.

### ■ FUELING THE UNIT

1. Untwist and remove the fuel cap. Rest the cap on a dustless place.
2. Put fuel into the fuel tank to 80% of the full capacity.
3. Fasten the fuel cap securely and wipe up any fuel spillage around the unit.

#### **▲ WARNING**

1. Select flat and bare ground for fueling.
2. Move at least 10 feet (3 meters) away from the fueling point before starting the engine.
3. Stop the engine before refueling the unit. At that time, be sure to sufficiently agitate the mixed gasoline in the container.

### ■ FOR YOUR ENGINE LIFE, AVOID:

1. FUEL WITH NO OIL (RAW GASOLINE) It will cause severe damage to the internal engine parts very quickly.
2. GASOHOL It can cause deterioration of rubber and/or plastic parts and disruption of engine lubrication.
3. OIL FOR 4-CYCLE ENGINE USE It can cause spark plug fouling, exhaust port blocking, or piston ring sticking.
4. **Mixed fuels which have been left unused for a period of one month or more** may clog the carburetor and result in the engine failing to operate properly.
5. In the case of storing the product for a long period of time, clean the fuel tank after rendering it empty. Next, activate the engine and empty the carburetor of the composite fuel.
6. In the case of scrapping the used mixed oil container, scrap it only at an authorized repository site.

#### **NOTE**

Do not use wasted or regenerated oil that can cause damage to the oil pump.

## 7. Operation

5. Set the stop switch to the — position. Set the throttle trigger to the start position (1 → 2 → 3). Place the unit on a flat, firm place. Keep the cutting head clear of everything around it.

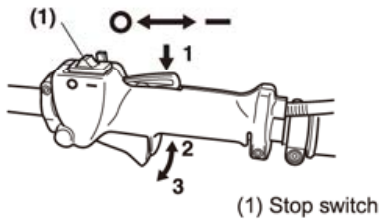

6. While holding the unit firmly, pull out the starter rope quickly until engine fires.



### ⚠ WARNING

The product is equipped with a centrifugal clutch mechanism, so the cutting attachment begins to rotate as soon as the engine is started by putting the throttle into the start position. When starting the engine, place the product onto the ground in a flat clear area and hold it firmly in place so as to ensure that neither the cutting part nor the throttle come into contact with any obstacle when the engine starts.

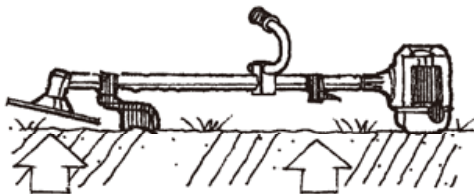

### ❗ IMPORTANT

Avoid pulling the rope to its end or returning it by releasing the knob. Such actions can cause starter failures.

7. Move the choke lever downward to open the choke. And restart engine.

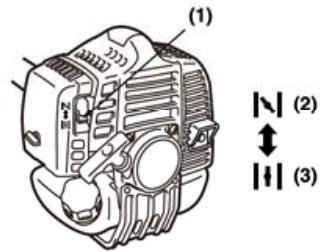

8. Allow the engine to warm up for a several minutes before starting operation.

### 📖 NOTE

- When restarting the engine immediately after stopping it, leave the choke open.
- Overchoking can make the engine hard to start due to excess fuel. When the engine failed to start after several attempts, open the choke and repeat pulling the rope, or remove the spark plug and dry it.

### STOPPING ENGINE

- Release the throttle lever and run the engine for half a minute.
- Shift the stop switch to the STOP position.

### ❗ IMPORTANT

Except for an emergency, avoid stopping the engine while pulling the throttle lever.

### ❗ IMPORTANT

When it doesn't stop at the stop switch, move the choke level to the closed position.

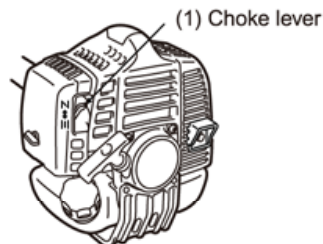

# 7. Operation

## ADJUSTING THROTTLE CABLE

The normal play is 1 or 2 mm when measured at the carburetor side end. Readjust with the cable adjuster as required.

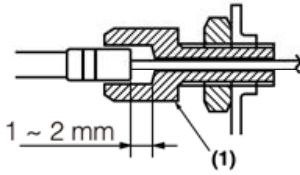

(1) Cable adjuster

## ADJUSTING IDLING SPEED

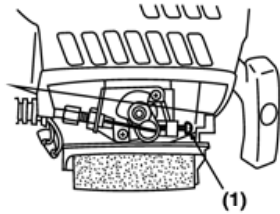

(1) Idle adjusting screw

1. When the engine tends to stop frequently at idling mode, turn the adjusting screw clockwise.
2. When the cutting head keeps rotating after releasing the trigger, turn the adjusting screw counter-clockwise.

## NOTE

Warm up the engine before adjusting the idling speed.

## WARNING

The cutting head will start rotating upon the engine starts.

1. Feed fuel into the fuel tank and tighten the cap securely.

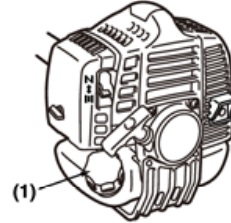

Feed the chain oil into the oil tank and tighten the cap securely, too.

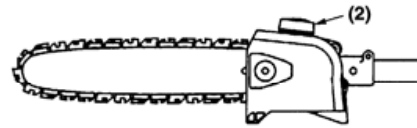

(1) Fuel (2) Chain oil

2. Rest the unit on a flat, firm place. Keep the cutting head off the ground and clear of surrounding objects, as it will start rotating upon starting of the engine.
3. Push the primer several times until overflowed fuel flows out in the clear tube.



4. Move the choke lever to the closed position.

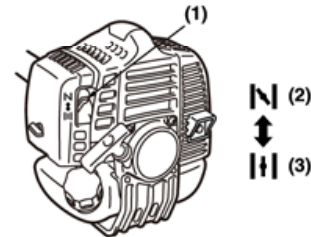

(1) Choke lever (2) Close (3) Open

# 7. Operation

## CUTTING WORK (LINE HEAD USAGE)

### **▲ WARNING**

1. Always wear eye protection such as safety goggles. Never lean over the rotating cutting head. Rocks or other debris could be thrown into eyes and face and cause serious personal injury.
2. Keep the cutting attachment guard in place at all times when the unit is operated.

## TRIMMING GRASS AND WEEDS

Always remember that the TIP of the line does cutting. You will achieve better results by not crowding the line into the cutting area. Allow the unit to trim at its own pace.

1. Hold the unit so the head is off the ground and is tilted about 20 degrees toward the sweep direction.













2. You can avoid thrown debris by sweeping from your left to the right.
3. Use a slow, deliberate action to cut heavy growth. The rate of cutting motion will depend on the material being cut. Heavy growth will require slower action than will light growth.
4. Never swing the unit so hard as you are in danger of losing your balance or control of the unit.
5. Try to control the cutting motion with the hip rather than placing the full workload on the arm and hands.
6. Take precautions to avoid wire, grass and dead, dry, long-stem weeds from wrapping around the head shaft. Such materials can stall the head and cause the clutch to slip, resulting in damage to the clutch system if repeated frequently.

## ADJUSTING THE LINE LENGTH

Our brush cutters are equipped with a semi- auto type nylon line head that allows the operator to advance the line without stopping the engine. When the line becomes short, lightly tap the head on the ground while running the engine at full throttle.

Each time the head is bumped, the line advances about 1 inch (25.4 mm). For better effect, tap the head on bear ground or hard soil. Avoid bumping in thick, tall grass as the engine may stall by overload.

## 7. Operation (Optional blade usage)

CUTTER APPLI- CATION CHART	9" 8-tooth:	9" 4-tooth:	Nylon line head
Heavy weeds 			
Light weeds 			
Grass 			

### CHOOSE THE BLADE

Choose a suitable recommended cutting attachment according to the object to be cut.

When replacing blade always be sure to use products, which have been certified by your supplier.

### ⚠ WARNING

When sharpening, removing, or reattaching the blade, be sure to wear thick, sturdy gloves and use only proper tools and equipment to prevent injury.

### SET UP

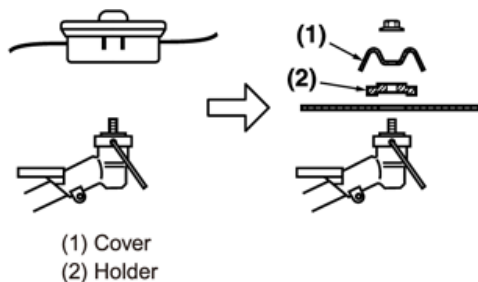

1. Detach the line head assembly completely.
2. Put on the blade, making the marked side face the holder, put on the outer holders, and fasten the blade with the blade nut.

### ⓘ IMPORTANT

Change the cutting attachment guard, which is suitable for the metal blade.

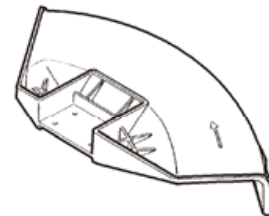

TIGHTENING TORQUE: 1.5 ~ 2.0 N.m.  
(0.15 ~ 0.2 kg.m.)

### ⓘ IMPORTANT

Change the loop handle to the J-handle for safe operation.

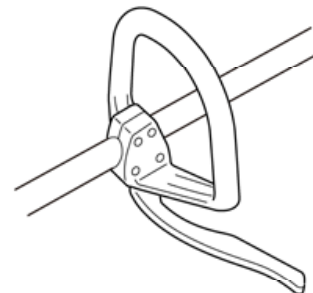



## 7. Operation (Optional blade usage)

### STARTING THE ENGINE

Please refer to 4. For safe operation, 7. Operation.

#### **▲ WARNING**

The product is equipped with a centrifugal clutch mechanism, so the cutting attachment begins to rotate as soon as the engine is started by putting the throttle into the start position. When starting the engine, place the product onto the ground in a flat clear area and hold it firmly in place to ensure that neither the cutting part nor the throttle come into contact with any obstacle when the engine starts.

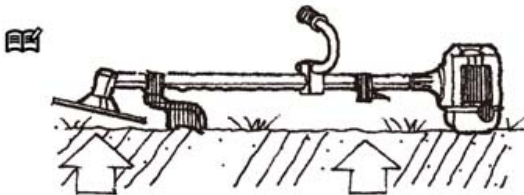

### CUTTING METHOD

- Use the front left side cutting.
- Guide the blade from your right to left with it tilted slightly to your left.



- When mowing a wide area, start working from your left end to avoid interference of cut grass.
- The blade may be seized by weeds if the engine speed is too low, or the blade cuts too deep into weeds. Adjust the engine speed and cutting depth according to the condition of object.

#### **▲ WARNING**

If the grass or other object gets caught in the blade, or if the unit starts to shake or vibrate, turn off the engine and check the whole unit. Change the blade if it has been damaged.

Turn off the engine and make sure the blade has completely stopped before checking the blade, and removing any object got caught in.

### OPERATION

- Check the bolt to fasten the blade and be sure the bolt has no fault, and no abrasion.
- Be sure that the blade and the holder have been fastened according to instruction and that the blade turns smoothly without abnormal noise.



#### **▲ WARNING**

The rotating parts fastened incorrectly may cause serious accident to the operator.

Make sure that the blade is not bent, warped, cracked, broken or damaged.

If you find any error to the blade, discard it and replace with a new one, which is certified by your supplier.

By using the shoulder strap, hang the unit on your right side. Adjust the strap length so that the cutting head may become parallel to the ground.



# 7. Operation (Optional blade usage)

## ⚠ WARNING

Make sure to use shoulder strap and cutting attachment guard. If not, it is very dangerous when you slip or lose your balance.

## ⚠ WARNING

### CONTROLLING BLADE BOUNCE

Blade thrust can cause serious personal injury. Carefully study this section. It is important that you understand what causes blade thrust, how you can reduce the chance of blade thrust and how you can remain in control of the unit if blade thrust does occur.

1. What causes blade thrust:  
blade thrust can occur when the moving blade contacts an object that it cannot cut. This contact causes the blade to stop for an instant and then suddenly move or ounce away from the object that was hit. The operator can lose control of the unit and the blade can cause serious personal injury to the operator or any person nearby if the blade contacts any part of the body.
2. How you can reduce the chance of blade thrust:
  - a. Recognize that blade thrust can happen. By understanding and knowing about bounce, you can help eliminate the element of surprise.
  - b. Cut fibrous weeds and grass only. Do not let the blade contact materials it cannot cut such as hard, woody vines and bushes or rocks, fences, metal, etc.
  - c. Be extra prepared for bounce if you must cut where you cannot see the blade making contact such as in areas of dense growth.
  - d. Keep the blade sharp. A dull blade increases the chance of bounce.
  - e. Avoid feeding the blade too rapidly. The blade can bounce away from material being cut if the blade is fed faster than its cutting capability.
  - f. Cut only from your right to your left.
  - g. Keep your path of advance clear of material that has been cut and other debris.
3. How you can maintain the best control:
  - a. Keep a good, firm grip on the unit with both hands. A firm grip can help neutralize bounce. Keep your right and left hands completely around the respective handles.
  - b. Keep both feet spread apart in a comfortable stance and yet braced for the possibility that the unit could bounce. Do not overreach. Keep firm footing and balance.

## MAINTENANCE

### BLADE

Check the blade and the fasteners for looseness, cracking, or bending.

Check the cutting edges and reform with a flat file.

Point:

### Saw blade



### 8-teeth blade

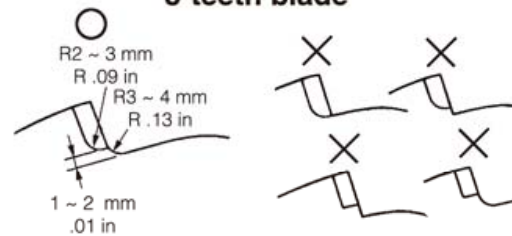

### 4-teeth blade

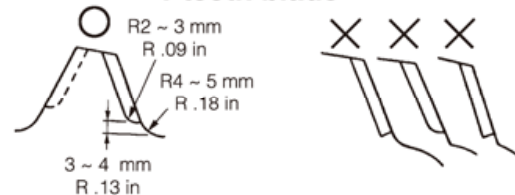

1. Keep the end corner sharp.
2. Round the root of the edge, using a round file.
3. Do not use water when using a grinder.

## ⓘ IMPORTANT

It is recommended that filing should be done by professionals.

Especially regarding filing the saw blade, leave it to the professionals.

## TRANSPORTING THE UNIT

When you finish cutting in one location and wish to continue work in another spot, turn off the engine, lift up the unit and carry it, paying attention to the blade. Never forget to place the protective cover over the blades.

When transporting the unit over long distances, detach the blade and fasten the unit by ropes.

## 7. Operation

### **⚠ WARNING**

This product is equipped with extremely sharp blades, and when used improperly these blades can be extremely dangerous and improper handling can cause accidents, which may in turn lead to serious injury or death. For this reason, you should always be careful to follow the following instructions when using your trimmer.

Never hold the trimmer in a way in which the blades are pointed towards someone else.

Never allow the blades to come into proximity with your body while the engine of the trimmer is in operation.

Always be sure to turn off the engine before changing the angle of the blades, removing branches which have become stuck in the blades, or at any other time when coming into close proximity with the blades.

Always wear work gloves made of leather or some other sturdy material when using the trimmer.

Always place the blade cover provided with the trimmer over the blades when not in use.

**Falling branches may fall onto the face or into the eyes, resulting in injuries, scratches, and cuts, and for this reason you should always be sure to wear a helmet and face protector when using your trimmer.**



### **❗ IMPORTANT**

The thickness of branches, which may be cut using this trimmer, is limited to up to approximately 3/16" (5 mm). Never try to cut branches thicker than this, as doing so may result in damage to the trimmer.

### **Adjusting the angle of the cutting blades**

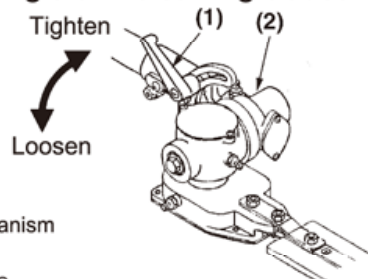

- (1) Clamp lever
- (2) Trimming mechanism

1. Stop the engine.
2. Turn the bolt located on the top of the trimming mechanism counter-clockwise to loosen it.
3. Adjust the angle of the blades to the desired angle, and then fix the bolt firmly back into place.

## 7. Operation

### **Checking oil supply**

After starting the engine, run the chain at medium speed and see if chain oil has scattered off, as shown in the figure.

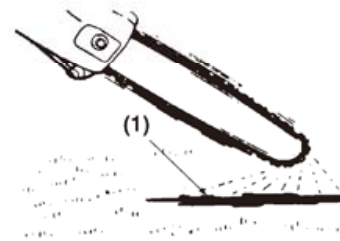

(1) Chain oil

### **📖 NOTE**

The oil reservoir has a capacity sufficient to provide about 40 minutes of cutting time (when set to deliver the minimum flow rate, or about as long as you get from a tank of fuel). Be sure to refill the oil tank every time when refueling the saw.

### **Adjusting Oil Flow Rate**

### **⚠ WARNING**

Never fill the oil reservoir nor adjust the oiler with the engine running.

### **❗ IMPORTANT**

An increase in bar oil flow rate will speed oil consumption, requiring more frequent checks on the oil reservoir. To ensure sufficient lubrication, it may be necessary to check the oil level more frequently than at fuel tank refills.

The guide bar and chain are lubricated automatically by a pump that operates whenever the chain rotates. The pump is set at the factory to deliver a minimum flow rate, but it can be adjusted in the field. A temporary increase in oil flow is often desirable when cutting things like hardwood or wood with a lot of pitch.

## 7. Operation

Adjust the pump as follows:

1. Stop the engine and make sure the stop switch is in the OFF position.
2. Place the unit on its side with the oil reservoir up.

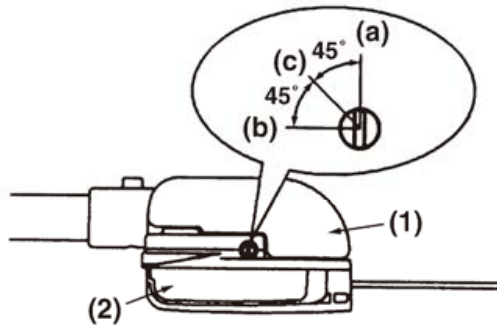

(1) Oil tank (2) Chain cover

### ⓘ IMPORTANT

The oil flow adjusting screw must be pressed in slightly in order to turn. Failure to do so could damage the pump and screw.

3. With a screwdriver, push in on the oil flow rate adjusting screw and turn in the desired direction (there are three incremental settings):
  - (a) Clockwise-decrease lubrication
  - (b) Counter clockwise-increase lubrication
  - (c) Middle

### ⚠ WARNING

**Always wear work gloves made of leather or some other sturdy material when using the polesaw. Falling branches may fall onto the face or into the eyes, resulting in injuries, scratches, and cuts, and for this reason you should always be sure to wear a helmet and face protector when using your polesaw.**



# 8. Maintenance

	System/components	Procedure	Before use	Every 25 hours after	Every 50 hours after	Every 100 hours after	Note
ENGINE	fuel leaks, fuel spillage	wipe out	✓				
	fuel tank, air filter, fuel filter	inspect/clean	✓	✓			replace, if necessary
	idle adjusting screw	see adjusting idling speed (p. 22)	✓				replace carburetor if necessary
	spark plug	clean and readjust plug gap			✓		GAP: .025 in (0.6 ~ 0.7 mm) replace, if necessary
	cylinder fins, intake air cooling vent	clean		✓			
	muffler, spark arrester, cylinder exhaust port	clean			✓		
SHAFT	throttle trigger, stop switch	check operation	✓				
	cutting parts	replace if somethings wrong	✓				
	transmission	grease		✓			
	screws/nuts/bolts	tighten/replace	✓			✓	not adjusting screws
	cutting attachment guard	make sure to attach	✓				
CUTTING UNIT	oiling port	clean	✓				
	guide bar	clean	✓				
	sprocket	inspect/replace			✓		
	saw chain	inspect/sharp	✓				

**⚠ WARNING**

Make sure that the engine has stopped and is cool before performing any service to the machine. Contact with moving cutting head or hot muffler may result in a personal injury.

**AIR FILTER**

The air filter, if clogged, will reduce the engine performance. Check and clean the filter element in warm, soapy water as required. Dry completely before installing. If the element is broken or shrunk, replace with a new one.

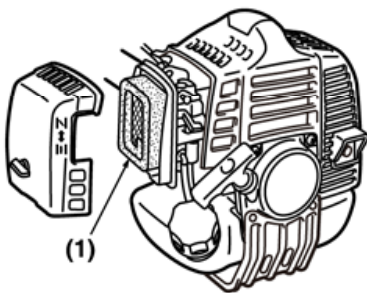

(1) Air filter

**FUEL FILTER**

When the engine runs short of fuel supply, check the fuel cap and the fuel filter for blockage.

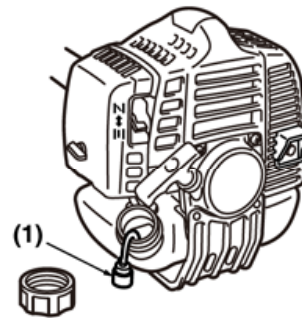

(1) Fuel filter

## 8. Maintenance

### SPARK PLUG

Starting failure and misfiring are often caused by a fouled spark plug. Clean the spark plug and check that the plug gap is in the correct range. For a replacement plug, use the correct type specified by your supplier.

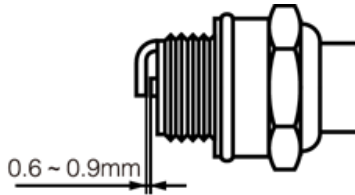

cause the engine to catch on fire. Always make sure that the muffler is clean and free of wood chips, leaves, and other waste before use.

Check the intake air cooling vent and the area around the cylinder cooling fins after every 25 hours of use for blockage, and remove any waste which has attached itself to the brushcutter. Note that it is necessary to remove the engine cover in order to be able to view the upper part of the cylinder.

### ❗ IMPORTANT

Note that using any spark plug other than those designated may result in the engine failing to operate properly or in the engine becoming overheated and damaged.

To install the spark plug, first turn the plug until it is finger tight, then tighten it a quarter turn more with a socket wrench.

TIGHTENING TORQUE: 9.8 ~ 11.8 N.m.  
(1 ~ 1.2 kg.m.)

### MUFFLER

### ⚠ WARNING

Inspect periodically, the muffler for loose fasteners, any damage or corrosion. If any sign of exhaust leakage is found, stop using the machine and have it repaired immediately.

Note that failing to do so may result in the engine catching on fire.

### INTAKE AIR COOLING VENT

### ⚠ WARNING

Never touch the cylinder, muffler, or spark plugs with your bare hands immediately after stopping the engine. The engine can become very hot when in operation, and doing so could result in severe burns.

When checking the machine to make sure that it is okay before using it, check the area around the muffler and remove any wood chips or leaves which have attached themselves to the brushcutter. Failing to do so could cause the muffler to become overheated and that in turn could

## 8. Maintenance

### ⓘ IMPORTANT

If waste gets stuck and causes blockage around the intake air cooling vent or between the cylinder fins, it may cause the engine to overheat, and that in turn may cause mechanical failure on the part of the brushcutter.

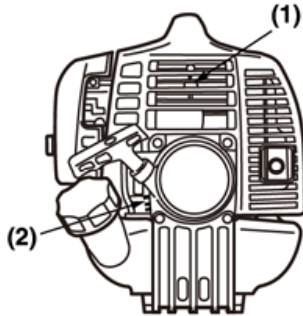

(1) Cylinder  
(2) Intake air cooling vent (back)

### PROCEDURES TO BE PERFORMED AFTER EVERY 100 HOURS OF USE



1. Remove the muffler, insert a screwdriver into the vent, and wipe away any carbon buildup. Wipe away any carbon buildup on the muffler exhaust vent and cylinder exhaust port at the same time.
2. Tighten all screws, bolts, and fittings.
3. Check to see if any oil or grease has worked its way in between the clutch lining and drum, and if it has, wipe it away using oil-free, lead-free gasoline.

## 8. Maintenance

### REFILLING TRIMMING LINE

1. For replacement line, use a diameter of 2.4mm (.095in). The spool is capable for a line upto 6m(20ft) on the 10cm(4 head. Avoid using a larger line as it may cut down the trimming performance.

### ⚠ WARNING

For safety reasons, do not use metalreinforced line.

2. Pinch the slotted area on the both sides of the spool housing to unhook the bottom cap.
3. Take out the spool and pull off the old line. Put one end of new line through the spool holes and pull it until the length is equal between each part of the line.
4. Wind up the line in the correct direction as indicated on the spool.
5. Hook each end of the line in the slot on the edge of the spool, and then put the ends through the eyelets on the housing. Make sure that the spring and the washers are in place.
6. While holding the spool against the housing, pull the line ends to release them from the slot.
7. Line up the slot on the bottom cap with the hook on the housing, press the cap against the housing until it clicks.

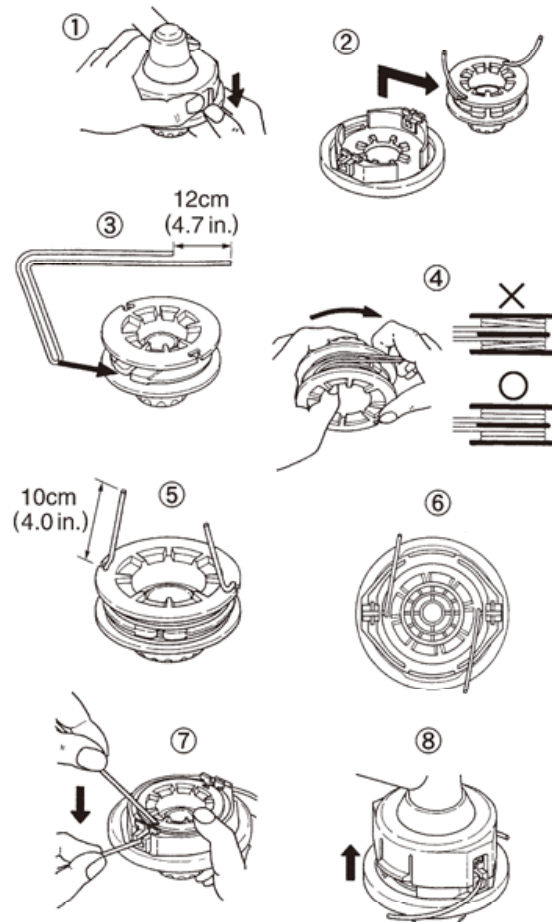

## 8. Maintenance

### ANGLE TRANSMISSION

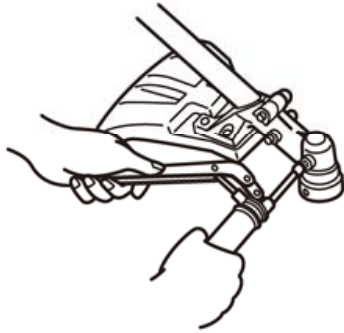

The reduction gears are lubricated by multipurpose, lithium-based grease in the angle transmission. Supply new grease every 25 hours of use or more often depending on the job condition. Remove the cutter holders before installing new grease to arrange for old grease to exit.

## 8. Maintenance

### BLADES

When refilling the tank or resting, it is often a good idea to use the time to oil the cutting blades.

If a gap exists between the upper and lower blades, follow the procedure below to adjust them so that they fit more closely together.

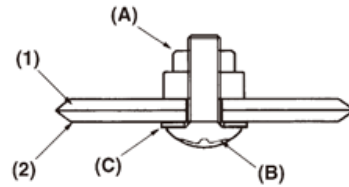

(1) Upper blade (2) Lower blade

1. Loosen lock nut (A) as shown in the diagram.
2. Tighten screw (B) fully, and then turn one-third to one-half of a rotation backward.
3. While holding onto the screw to keep it in position, tighten the lock nut.
4. Check to make sure that the flat washer (C) is loose enough so that it may be turned by pressing on it with a finger.

#### NOTE

Screwing in the screw too tightly may make it impossible for the blades to move. Conversely, not screwing in the screw tightly enough may make the blades of the trimmer feel dull and cause leaves and branches to become caught in the blades of the trimmer.

#### QUICK TIP

If the blades become so worn down that it is no longer possible to eliminate the gap between them, you should contact the authorized servicing dealer from which you purchased your trimmer to have the blades resharpened or replaced.

### TRANSMISSION

The reduction gears are lubricated by multipurpose, lithium-based grease in the transmission. Supply new grease every 25 hours of use or more often depending on the job condition.

When adding lubricant, use a grease gun to insert lubricant into the three grease nipples located on the transmission.

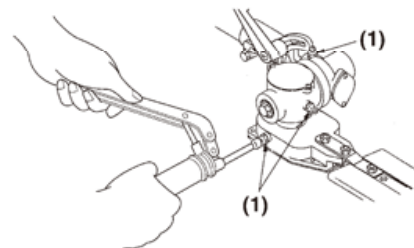

(1) Grease fitting



# 8. Maintenance

## OILING PORT

Dismount the guide bar and check the oiling port for clogging.

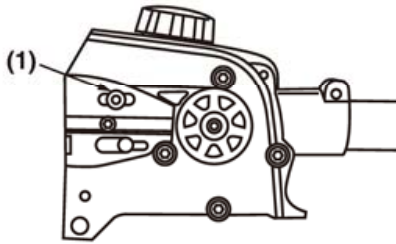

(1) Oiling port

## GUIDE BAR

Remove sawdust in the bar groove and the oiling port.

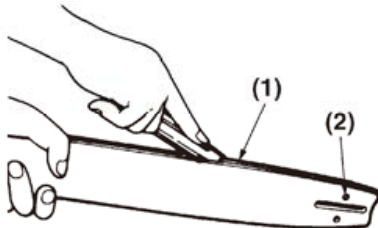

(1) Groove (2) Oiling port

(Type: Sprocket nose)

Grease the nose sprocket from the feeding port on the tip of the bar.

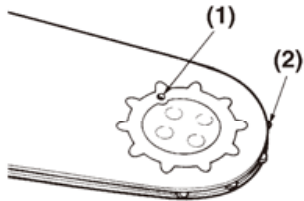

(1) Grease port (2) Sprocket

The bar rail should always be a square. Check for wear of the bar rail. Apply a ruler to the bar and the outside of a cutter. If a gap is observed between them, the rail is normal. Otherwise, the bar rail is worn. Such a bar needs to be corrected or replaced.

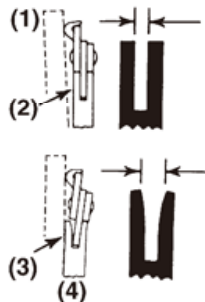

(1) Ruler (2) Gap  
(3) No gap (4) Chain tilts

## SPROCKET

Check for extensive wear, and replace it when the teeth are worn over 0.3 mm.

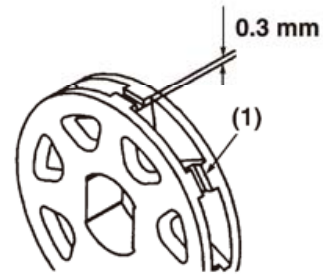

(1) Sprocket

## SAW CHAIN

### ⚠ WARNING

It is very important for smooth and safe operation to keep the cutters always sharp.

Your cutters need to be sharpened when:

- Sawdust becomes powder-like.
- You need extra force to saw in.
- The cut way does not go straight.
- Vibration increases.
- Fuel consumption increases.

### Cutter setting standards:

### ⚠ WARNING

Be sure to wear safety gloves.

Before filing:

- Make sure the saw chain is held securely.
- Make sure the engine is stopped.
- Use a round file of proper size for your chain.

## 8. Maintenance

Place your file on the cutter and push straightforward. Keep the file position as illustrated.

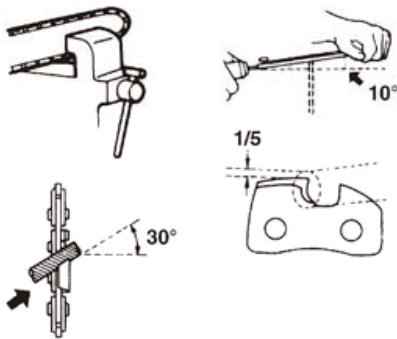

After every cutter has been set, check the depth gauge and file it to the proper level as illustrated.

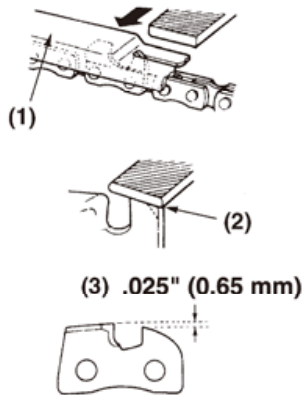

- (1) Appropriate gauge checker
- (2) Make the shoulder round
- (3) Depth gauge standard

### **▲ WARNING**

Be sure to round off the front edge to reduce the chance of kickback or tie-strap breakage.

Make sure every cutter has the same length and edge angles as illustrated.

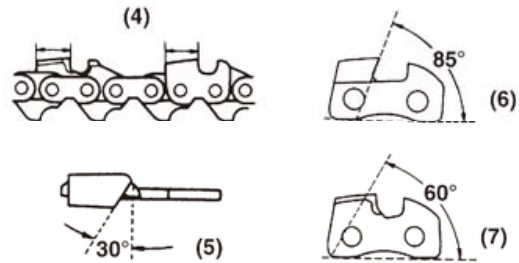

- (4) Cutter length
- (5) Filing angle
- (6) Side plate angle
- (7) Top plate cutting angle

### **TRANSMISSION**

The reduction gears are lubricated by multipurpose, lithium-based grease in the transmission.

Supply new grease every 25 hours of use or more often depending on the job condition.

When adding lubricant, use a grease gun to insert lubricant into the three grease nipples located on the transmission.

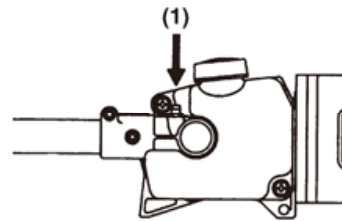

- (1) Grease fitting

## TRANSMISSION

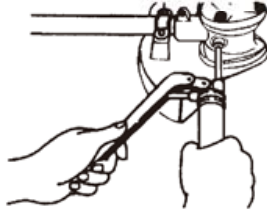

The reduction gears are lubricated by multipurpose, lithium-based grease in the transmission. At every 20 hours of use, supply the transmission with new grease. Remove the cutter holders before installing new grease to arrange for old grease to exit.

### NOTE

When removing and installing the cutter holder (a), use care not to allow any dirt and dust entering in to the transmission.

Aged fuel is one of major causes of engine starting failure. Before storing the unit, empty the fuel tank and run the engine until it uses all the fuel left in the fuel line and the carburetor. Store the unit indoor taking necessary measures for rust prevention.

## 9 . Disposal

When disposing your machine, fuel or oil for the machine, be sure to allow your local regulations.

## 10. Troubleshooting guide

### Case 1. Starting failure

CHECK	PROBABLE CAUSES	ACTION
fuel tank	→ incorrect fuel	→ drain it and use correct fuel
fuel filter	→ fuel filter is clogged	→ clean
carburetor adjustment screw	→ out of normal range	→ adjust to normal range
sparkign (no spark)	→ spark plug is fouled/wet → plug gap is incorrect	→ clean/dry → correct (GAP: 0.6 ~ 0.7 mm)
spark plug	→ disconnected	→ retighten

### Case 2. Engine starts but does not keep running/hard re-starting

CHECK	PROBABLE CAUSES	ACTION
fuel tank	→ incorrect fuel or staled fuel	→ drain it and use correct fuel
carburetor adjustment screw	→ out of normal range	→ adjust to normal range
muffler, cylinder (exhaust port)	→ carbon is built-up	→ wipe away
air cleaner	→ clogged with dust	→ wash
cylinder fin, fan cover	→ clogged with dust	→ clean

When your unit seems to need further service, please consult with our service shop in your area.

## ***EC Declaration of Conformity***

We: JINHUA TENWELL TECH CO., LTD

Room 2509, BUILDING 4, JINHUA WANDA PLAZA, JINHUA CITY, ZHEJIANG, P.R. CHINA

Declare that the Product detailed below:

**MULTI-FUNCTIONAL TOOL 5IN1**

**Model: ASMT 2600-3**

**Serial No.: 0001~9999**

**Brand: AOSOME®**

Satisfies the requirement of the Council Directives:

Machinery Directive 2006/42/EC

Electromagnetic Compatibility Directive EMC 2004/108/EC

Noise Directive 2000/14/EC (Measured sound power level: 102dB (A),

Guaranteed sound power level: 111dB (A)

Emission directive 97/68/EC

Notified body: TÜV SÜD Product Service GmbH

Ridlestraße 65, 80339 München, Germany

Number of notified body: 0123

and conforms to the norms:

**EN ISO 11806-1: 2011**

**EN ISO 11680-1: 2011**

**EN ISO 10517: 2009**

Position of Signatory:

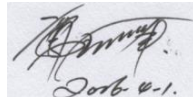

Leo Guo

Director of research and development department

Date: 01-04-2016

ASMT 2600-3

---